



POSTURAL SUPPORT

S O L U T I O N S



neoflex

POSTURAL SUPPORT SOLUTIONS

Correct positioning is essential for wheelchair users to maintain comfort, independence, and overall health. In addition to the physical benefits of correct positioning, the importance of positioning in social settings and daily interactions is not to be underestimated.

Neoflex is a full range of neoprene positioning solutions to provide the best postural support specifically designed for wheelchair users. Aimed at providing maximum

function, comfort, support, and safety, Neoflex is made for wheelchair users in need of additional support.

Whether you are a care professional looking to help your patients or a wheelchair user in need of postural support, this range provides a wide selection of belts, harnesses and supports to create a personalised solution for wheelchair users, adaptable to their needs or use of their wheelchair.

European design and quality

VERMEIREN
we care for you

Neoflex is a range of positioning support solutions created by **VERMEIREN**. Vermeiren is an international company that specialises in producing mobility solutions, including wheelchairs, mobility scooters, and other devices designed to help individuals with mobility limitations. With over 65 years of experience in the industry, Vermeiren has established itself as a leading provider of high-quality mobility products. One of the key values at Vermeiren is our commitment to research and development.

We work closely together with healthcare professionals and users to design products that meet the evolving needs of our customers. From ergonomic designs to cutting-edge materials and technologies, we are always pushing the boundaries of what is possible within the mobility solutions industry.

Our slogan, "We care for you" is therefore not just a slogan. Our products are designed to suit you, your lifestyle and your needs.



The smile of a person who can freely connect with their environment and enjoy social settings is priceless to me. The belts allow patients to confidently participate while feeling comfortable and safe.

Artur Skubera

Physiotherapist and clinical advisor at Vermeiren

I need to feel stable and safe to give my best performance. Neoflex is the perfect partner for stability when I play.

José Coronado

Spanish Tennis player and Vermeiren Ambassador



Neoflex Materials

All Neoflex support solutions use very soft and stretchable Neoprene fabric. This high-quality material is resistant to wear and tear from daily use, UV rays, oxidation and much more. Thanks to the strategic processing of the fabric, our stitching provides the perfect combination of stretch and rigidity to provide the best support and comfort.

All Neoflex belts are breathable due to an ingenious design with permeable layered materials, reducing the risk of ulceration or irritation caused by excessive heat and moisture. Our support solutions are designed to be durable without sacrificing the user's comfort. All our Neoflex products are machine washable to ensure the highest standards of hygiene. Please consult our manuals for washing instructions.

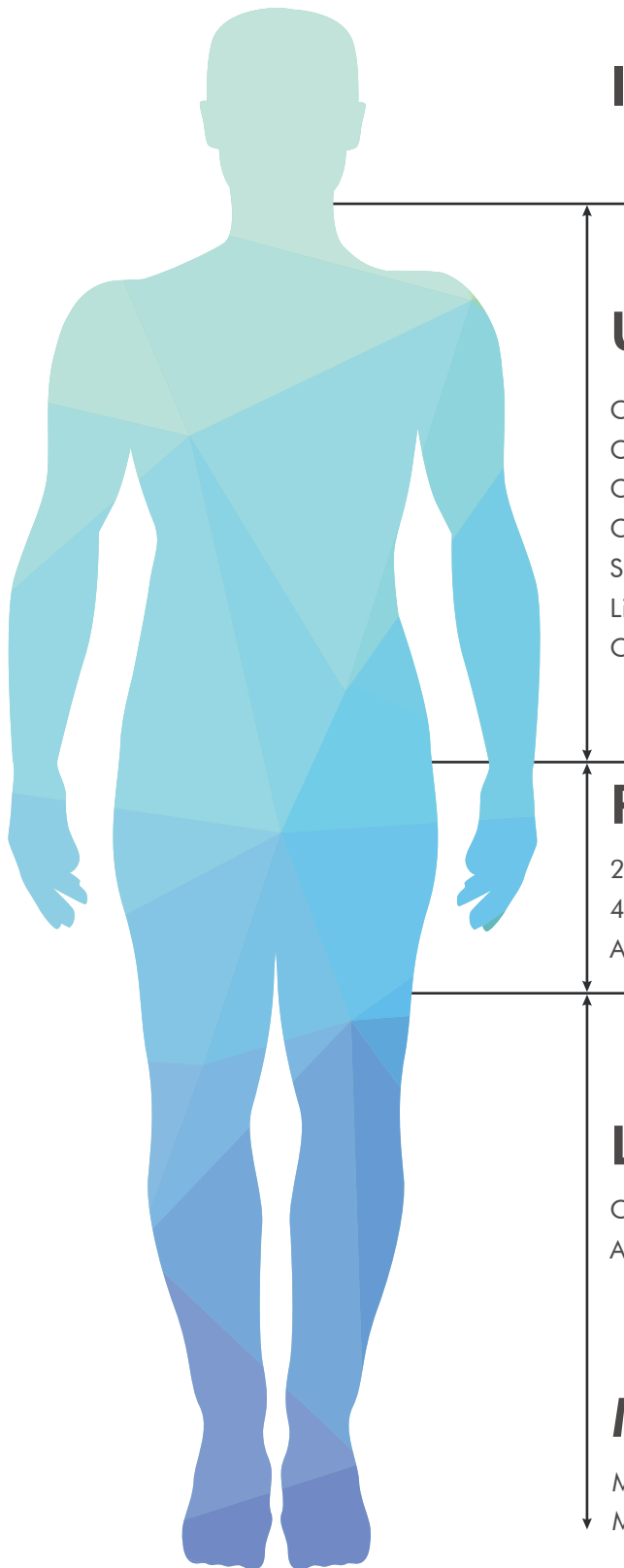

Index

Upper body - Neo 20

| | |
|---|----|
| Chest support - wide. Neo 20.01 | 7 |
| Chest support with zipper - wide. Neo 20.02 | 8 |
| Chest support - slim. Neo 20.03 | 9 |
| Chest support with zipper - slim. Neo 20.04 | 9 |
| Shoulder harness. Neo 20.05 | 10 |
| Linked shoulder harness. Neo 20.06 | 10 |
| Chest belt. Neo 20.07 | 11 |

Pelvic Positioning - Neo 30

| | |
|------------------------------|----|
| 2 points hip belt. Neo 30.01 | 13 |
| 4 points hip belt. Neo 30.02 | 14 |
| Abduction control. Neo 30.03 | 15 |

Lower body - Neo 40

| | |
|--------------------------|----|
| Calf band. Neo 40.01 | 17 |
| Ankle control. Neo 40.02 | 17 |

Multi-use band - Neo 00

| | |
|-------------------------------------|----|
| Multi-use band. Neo 00.01 | 18 |
| Multi-use band extension. Neo 00.02 | 18 |



UPPER BODY

Proper upper-body positioning is of vital importance for wheelchair users, ensuring their comfort, independence and overall well-being. In addition to the physical benefits of correct positioning, the importance of positioning in social settings, communication and daily interactions is not to be underestimated. Correct posture and positioning of the upper body

ensure even distribution of weight and pressure on the body, reducing the risk of strain, uncomfortable pressure, reduced blood flow or any other discomfort caused by incorrect positioning. Our postural support solutions help improve stability as well as reduce involuntary movement or sliding when seated in a wheelchair.

Stabilization of the upper body

Optimal trunk positioning is vital for stability and effective upper body function. Postural upper body solutions help maintain or support neutral and good upper body positioning to improve daily activities and provide a balance between support, freedom of movement and optimal placement of force on the body.

Neoflex chest supports provide trunk control and stability by supporting the chest and shoulder joints without reducing the movement of the arms or shoulders. A perfect balance between support and movement supporting a correct upper-body positioning. It also promotes contact of the upper body with the back support of the wheelchair.



Chest Support - Wide
Sizes: XS-S-M-L-XL



Chest Support with zipper - Wide
Sizes: XS-S-M-L-XL



Chest Support - Slim
Sizes: XS-S-M-L-XL



Chest Support with zipper - Slim
Sizes: XS-S-M-L-XL

Chest support - wide Neo 20.01

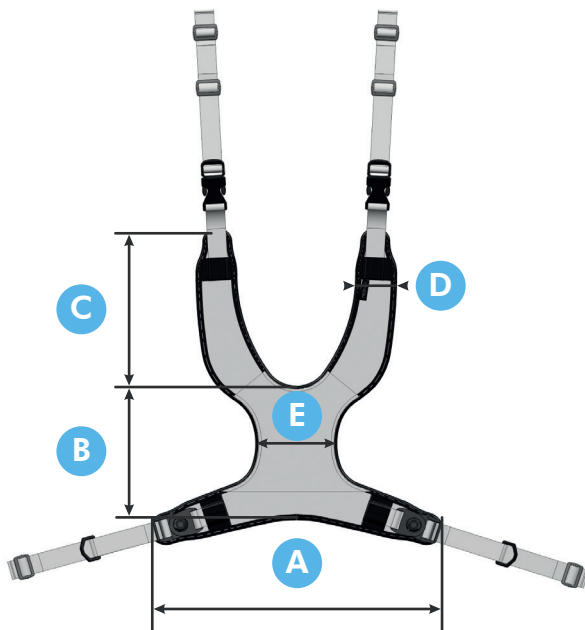

| | A | B | C | D | E |
|----|----|----|----|-----|----|
| XS | 28 | 13 | 13 | 4 | 5 |
| S | 29 | 14 | 17 | 4,5 | 8 |
| M | 36 | 18 | 22 | 5 | 11 |
| L | 44 | 21 | 25 | 6 | 11 |
| XL | 52 | 25 | 27 | 6 | 13 |

Measurements in cm.

Chest Support with zipper - wide

Neo 20.02

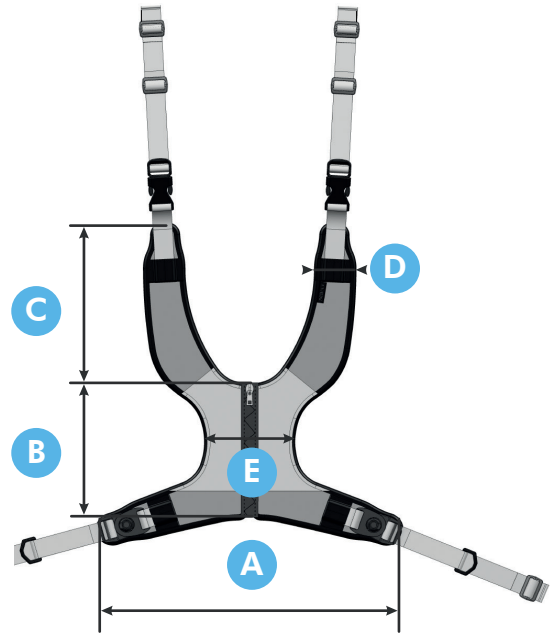

| | A | B | C | D | E |
|----|----|----|----|-----|----|
| XS | 28 | 13 | 13 | 4 | 5 |
| S | 29 | 14 | 17 | 4,5 | 8 |
| M | 36 | 18 | 22 | 5 | 11 |
| L | 44 | 21 | 25 | 6 | 11 |
| XL | 52 | 25 | 27 | 6 | 13 |

Measurements in cm.



Chest Support - slim

Neo 20.03

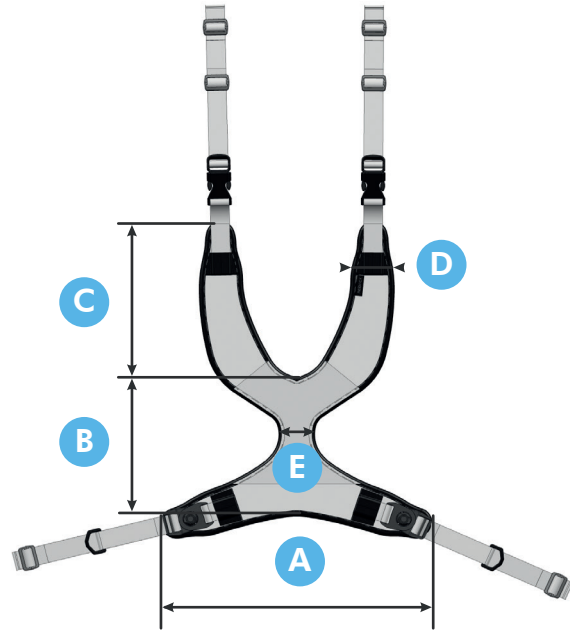

| | A | B | C | D | E |
|----|----|----|----|-----|---|
| XS | 28 | 13 | 13 | 4,5 | 5 |
| S | 29 | 14 | 17 | 4,5 | 5 |
| M | 36 | 18 | 22 | 5 | 5 |
| L | 41 | 21 | 22 | 6 | 5 |
| XL | 49 | 23 | 25 | 6 | 5 |

Measurements in cm.

Chest Support with zipper - slim

Neo 20.04

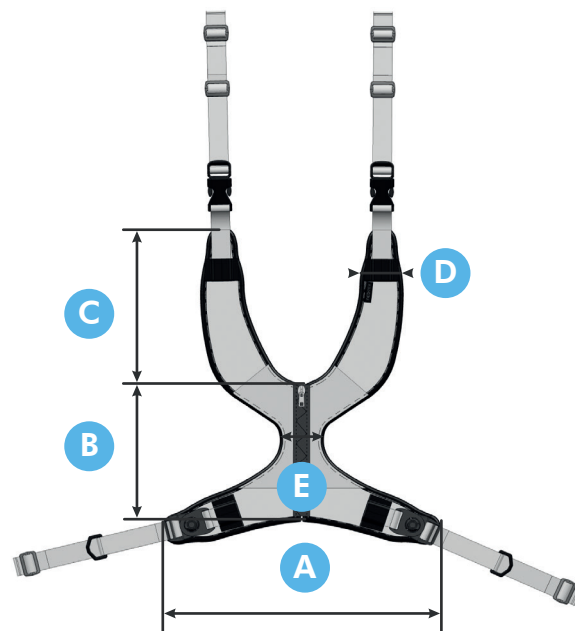

| | A | B | C | D | E |
|----|----|----|----|-----|---|
| XS | 28 | 13 | 13 | 4,5 | 5 |
| S | 29 | 14 | 17 | 4,5 | 5 |
| M | 36 | 18 | 22 | 5 | 5 |
| L | 41 | 21 | 22 | 6 | 5 |
| XL | 49 | 23 | 25 | 6 | 5 |

Measurements in cm.

Shoulder harness

Neo 20.05

In cases of involuntary shoulder rotation, head imbalance, spine rigidity and/or pain in the back, Neoflex shoulder harnesses provide shoulder retraction while accommodating shoulder asymmetry.

A linked shoulder harness (Neo 20.06) is also available to equalize tension between both shoulder straps while preventing instability or sliding of the straps.

Retracting the shoulders in an upright position promotes breathing, better head control and stabilisation of the upper body without restricting any movement in the ribs or freedom of movement of the arms while seated in a wheelchair.

| | A | B |
|----|----|-----|
| S | 30 | 6 |
| M | 35 | 7 |
| L | 40 | 7 |
| XL | 47 | 7,5 |

Measurements in cm.

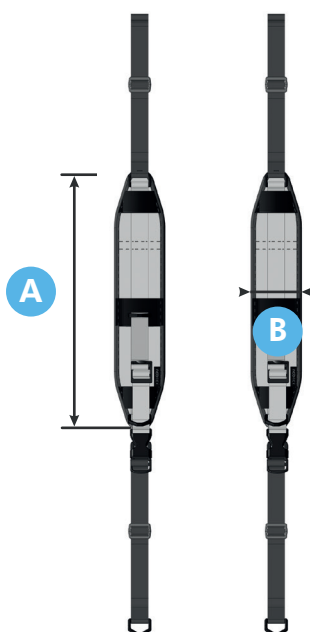

Linked shoulder harness

Neo 20.06

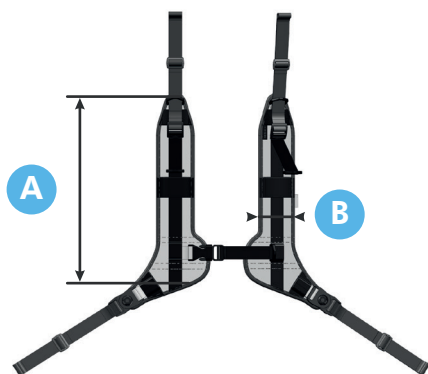

| | A | B |
|----|----|-----|
| S | 35 | 6 |
| M | 38 | 7 |
| L | 45 | 7 |
| XL | 51 | 7,5 |

Measurements in cm.



Chest belt

Neo 20.07

The Neoflex chest belt provides excellent upper-body and trunk support. The chest belt can be installed both at chest height and at upper abdomen height to suit the user's needs. Its installation on the upper abdomen helps lift the diaphragm, improving respiration, verbal communication and swallowing.

A simple support, such as the chest belt, is often sufficient when stability is the primary

need. Neoflex upper body supports benefit the positioning of the upper body and, subsequently, other body parts as well.

By using Neoprene, the material comfortably adapts and stretches without compromising on support. The machine-washable material ensures comfortable and hygienic upper body support, making it perfect for frequent use.

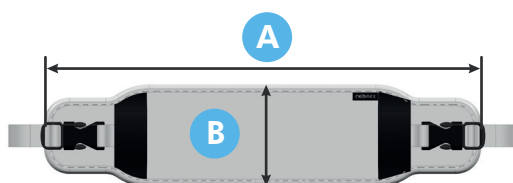

| | A | B |
|----|----|------|
| XS | 31 | 8,5 |
| S | 39 | 10,5 |
| M | 47 | 12 |
| L | 57 | 12 |
| XL | 65 | 13,5 |

Measurements in cm.



PELVIC POSITIONING

Pelvic positioning refers to the orientation and alignment of the pelvic bones, which form an important part of the human body. The pelvis is a set of bones that connect the trunk to the legs, support the upper body and contain some vital organs. A neutral pelvic position is therefore vital to ensure optimal posture and positioning for efficient and comfortable movement and function of the hips and lower back, and of course, for the best posture.

Pelvic positioning can have a significant impact on posture, movement, and overall physical health. Proper alignment of the pelvis provides even pressure distribution and helps reduce the risk of injury and pain in the lower back, hips, and legs.

Neoflex offers a selection of pelvic support solutions to suit individual requirements and needs, ranging from mild to strong support.



2-points hip belt
Sizes: S-M-L



4-points hip belt
Sizes: S-M-L



Neoflex Abduction control
Sizes: XS-S-M-L-XL

2-Points hip belt

Neo 30.01

Neoflex 2-Point Hip Belt with two points of attachment to the wheelchair provides support for the user's pelvis. In combination with our clamps and mounting fasteners, mild to moderate pressure can be applied to discourage slipping.

The hip belt has two padded pieces to promote even pressure distribution and comfort. The tension and applied pressure can easily be adjusted with the straps.

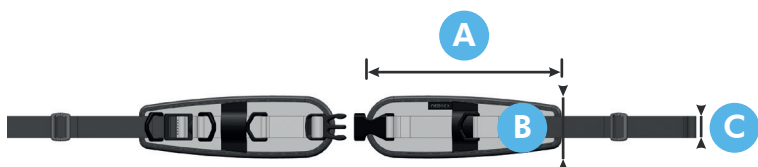
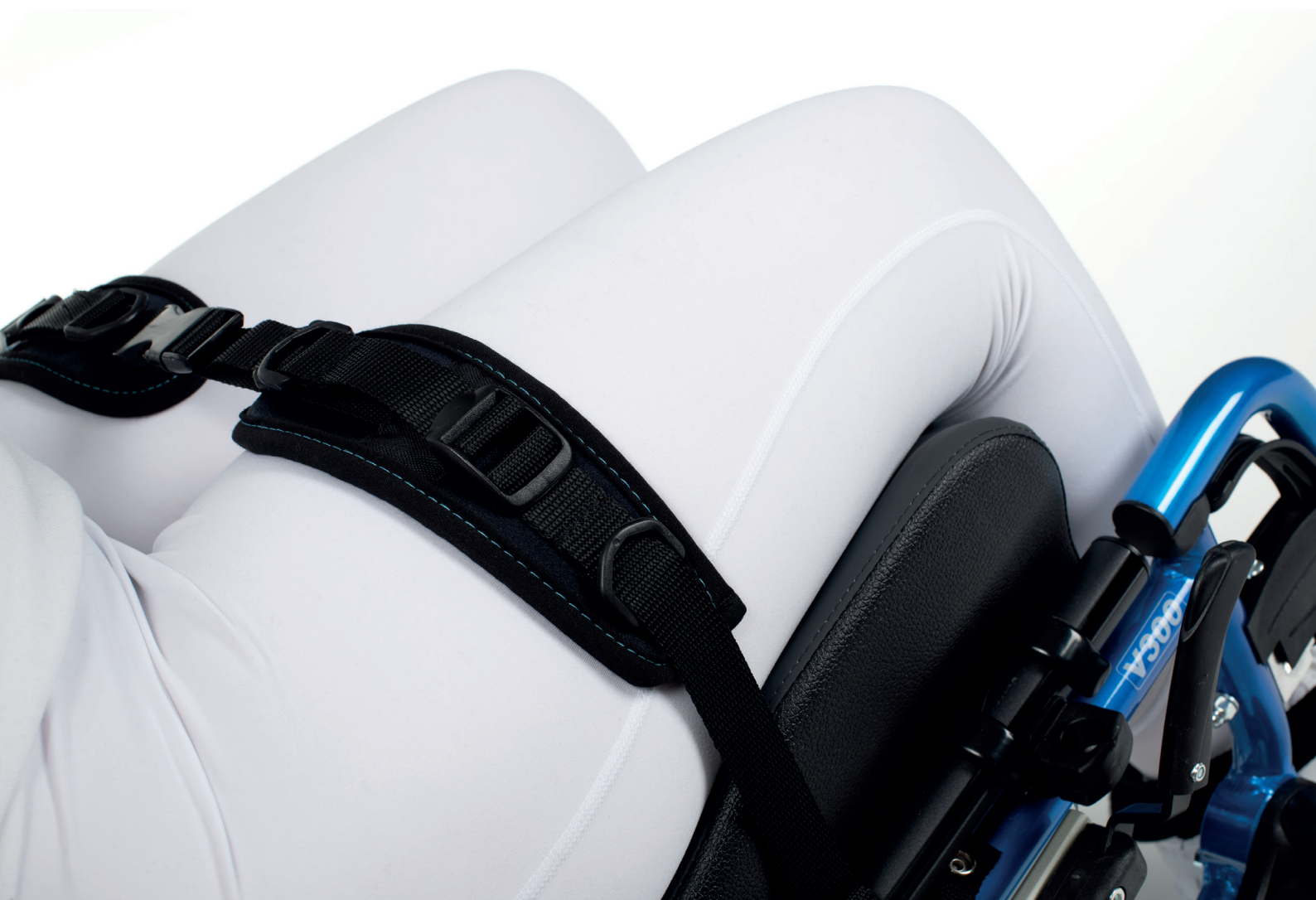

| | A | B | C |
|----|----|---|-----|
| XS | 11 | 7 | 2,5 |
| S | 17 | 7 | 2,5 |
| M | 22 | 7 | 2,5 |
| L | 27 | 7 | 2,5 |

Measurements in cm.

4-Points hip belt

Neo 30.02

Neoflex 4-point hip belt offers the same benefits as the 2-point hip belt, but with 2 additional attachment straps. The secondary straps ensure that the hip

belt does not twist or move out of the required position. This belt is ideal for anterior pelvic tilt, pelvic rotation and thrusting.

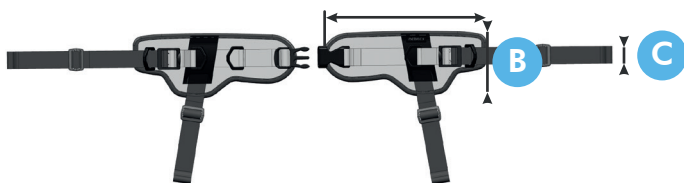

| | A | B | C |
|----|----|---|-----|
| XS | 11 | 7 | 2,5 |
| S | 17 | 9 | 2,5 |
| M | 22 | 9 | 2,5 |
| L | 27 | 9 | 2,5 |

Measurements in cm.

Abduction control

Neo 30.03

Use the abduction strap to replace the traditional abduction block in order to prevent compression on the knees. Easy to install in any kind of wheelchair. It's a perfect solution for those with high muscle tension or spasticity to prevent extreme compression of the knees and reduce the risk of

hip dislocation. The belt is made from Neoprene to limit involuntary movement without restricting freedom of the leg or putting pressure on the bladder. This product is compatible with Neoflex hip belts.

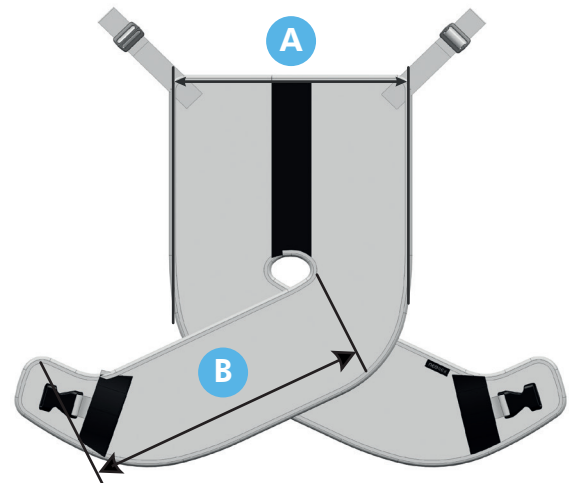

| | A | B |
|----|----|----|
| XS | 17 | 18 |
| S | 22 | 28 |
| M | 27 | 35 |
| L | 34 | 40 |

Measurements in cm.



LOWER BODY

Overall, proper lower-body positioning in a wheelchair involves maintaining proper alignment and support to prevent discomfort, injury, and other complications associated with prolonged

sitting. The lower body plays a vital role in good posture and positioning for wheelchair users. A healthcare professional will be able to optimise the use of Neoflex according to your needs.



Calf band
Sizes: S-M-L-XL



Ankle control
Sizes: XS-S-M-L-XL

Calf band

Neo 40.01

A calf support band that offers comfortable stabilisation and positioning of the lower legs without restricting any movement or applying

unnecessary pressure. The calf support is suitable for most wheelchairs with leg rests and is perfect in combination with our wheelchairs.

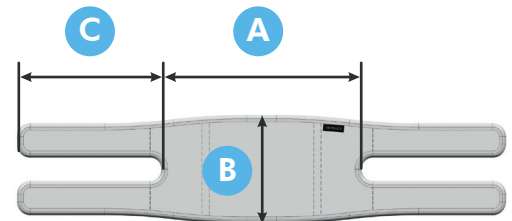

| | A | B | C |
|----|----|------|----|
| S | 19 | 12 | 15 |
| M | 27 | 14 | 19 |
| L | 35 | 16,5 | 25 |
| XL | 41 | 16,5 | 25 |

Measurements in cm.

Ankle control

Neo 40.02

A comfortable stabilisation support to improve positioning of the lower legs on a wheelchair. The straps attach easily to any wheelchair.

This support is useful for both stabilisation and correct positioning of the lower legs if needed.

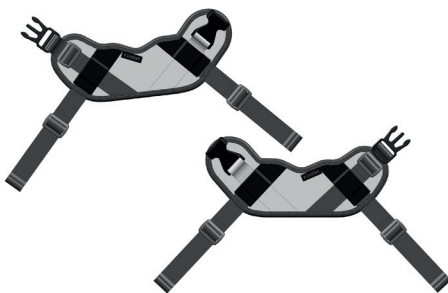

| ANKLE CIRCUMFERENCE | |
|---------------------|---------|
| XS | 14 - 17 |
| S | 17 - 20 |
| M | 19 - 23 |
| L | 22 - 29 |
| XL | 28 - 33 |

Measurements in cm.



Multi-use band

Neo 00.01

This multi-use band is an all-around solution to support wheelchair users with various needs. The strong Neoprene belt can be used on the chest, abdomen, legs, etc. and is adaptable to most wheelchairs and

users without any additional hardware or costs. The easy-grasp end tab with a pocket helps users with limited hand function use this belt independently.

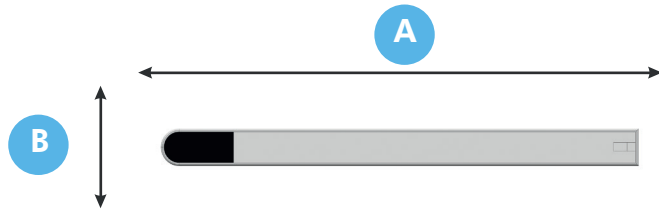

| | A | B |
|----|-----|----|
| S | 100 | 8 |
| M | 140 | 10 |
| L | 160 | 10 |
| XL | 180 | 10 |

Measurements in cm.



Multi-use band extension

Neo 00.02

Extend our Multi-use band with this 80 cm band extension.

Multi-use band extension



Multi-use band

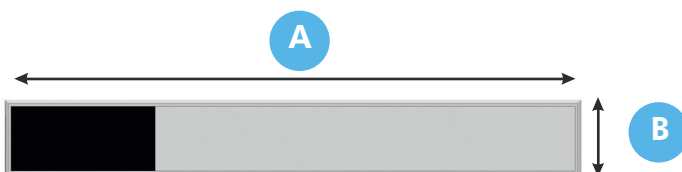

| | A | B |
|---|----|----|
| S | 80 | 8 |
| M | 80 | 10 |

Measurements in cm.

WASHING INSTRUCTIONS



All of our Neoflex products are machine washable up to 40°C for the best hygienic standards, even when used daily. Please consult our manuals for detailed washing instructions.



Neoflex postural solutions are not suitable for the dryer. To protect your Neoflex and prolong its service life, we recommend air-drying our products.

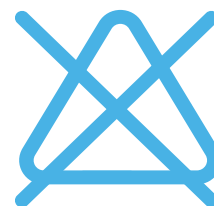

To protect the high-quality materials used in the Neoflex, we recommend using normal washing liquid. Bleach, fabric softener, or any type of solvent are not recommended.

HARDWARE



Triangular clamp for Trigo wheelchair



Round tube clamp



Metal bridge clamp
Available Ø19, Ø22, Ø25, Ø29, Ø30, Ø35mm



Cinch profile for INOVYS wheelchair



L34 back support system





neoflex
POSTURAL SUPPORT SOLUTIONS

